

Non-Expression

Genesis 1:11 of Bible - KJV
 "... Hast thou eaten of the tree, whereof I commanded thee that thou shouldst not eat?"

Every Any Some Non

Functional Open Domain

Express-ability

ZMO ... Creative Math and Art
 New Math Foundations and Logic.

1

Mankind's Quest for Open Domain Dominion & Development.

Functional Open Domain

A Survey...The "Open Domain" has been a target of many of Mankind's endeavors. After a quick survey of some of these efforts and recognized commentary, I came to the conclusion that the reason for the overwhelming dissatisfaction is that there is no such thing as an open domain. ...

2

Functional Open Domain

Mathematics implies a claim to an open domain with axioms of develop-ability and reducibility. Our creative souls attempt sovereignty with sheer creative abilities. Adam from the Bible I guess figured he could create as G-d evidently had and achieve a dominion of an open domain of his own. Jesus of Christianity is accused of assuming open domain ownership, but upon thorough inspection of the Bible He promised Man-kind only access to Principal and Principal Open Domain express-ability. The dominion of expression of expression(s) methodologies on Earth precludes us to this fate and destination.

3



4

This is Zim Olson. "Open Domain Development" is an important aspect to Human Knowledge Development, however it has been easily not fully appreciated or understood. Mathematics and Logical understanding of this domain has been largely inadequate. Express-ability has been our only recognized avenue to open domain development, but has also served equally as our source to Human problems. Principal open domain development I suggest as our viable methodology alternative.

5

<p>Principal Non-Expression</p> <p>Jesus Earth "Knowledge" Kingdom</p> <p>— — — — — ... — ————— (1)=(0)=(1+0)</p>	<p>Jesus Principal Express-ability</p> <p>— — — — — ... — ————— (1)=(0)=(1+0)=(1,0)</p>
---	---

6

Available Earthly Express-ability

—
— —
— — ... —
—————
(1)=(0)=(1+0)=(1or0)=(1,0)

7

Domain Development with Express-ability and Available Object(s) Variations

8

I got the idea for this slide from church, while congregation sang Christian songs. It is not necessary to fathom express-ability or even principal express-ability with such behavior, like the birds singing each morning. Combinations, permutations, of object and /or object(s) variations could easily give us the new and additional express-ability. Computer calculating power could achieve this same thing in seconds.

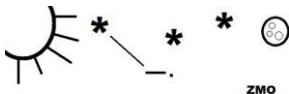

$+ f(_) \Rightarrow _.$
 $+ f(_, _) \Rightarrow _.$
 $+ f(_, _, \dots) \Rightarrow _.$

 $+ f(_) \Rightarrow _, _.$
 $+ f(_, _) \Rightarrow _, _.$
 $+ f(_, _, \dots) \Rightarrow _, _.$

 $+ f(_) \Rightarrow _, _, \dots.$
 $+ f(_, _) \Rightarrow _, _, \dots.$
 $+ f(_, _, \dots) \Rightarrow _, _, \dots.$

K
n
o
w
i
n
g
o

Source

9

Systems Math and Objectivity

Scientific Method has relied on Objectivity as a source to so called reproducibility of expression outcomes. This reproducibility did not include a Uni-Version express-ability of all object(s) as system(s). Any so called Scientific reproducibility of outcomes relied on implied system(s) parameterization of any object(s). The so called outcomes and Scientific domains of express-ability and "Reality" interestingly provide only limited and terminal outcomes. Giving an entirely problematic and systemically limited express-ability. Not so helpful in the long run.

10

Systems Math and Objectivity

Self Expression still serves as our primary and principal source to measures of objectivity.

System(s)

$\text{Every}(W) \text{Any}(X) \text{Some}(Y) \text{Non}(Z)$
 $\text{Every}(W) \text{Any}(W) \text{Some}(Y) \text{Non}(Z)$
 $\text{Every}(W) \text{Any}(W) \text{Some}(W) \text{Non}(Z)$
 $\text{Every}(W) \text{Any}(W) \text{Some}(W) \text{Non}(W)$
 $\text{Every}(W) \text{Any}(X) \text{Some}(W) \text{Non}(Z)$
 $\text{Every}(W) \text{Any}(X) \text{Some}(Y) \text{Non}(W)$
 $\text{Every}(W) \text{Any}(X) \text{Some}(W) \text{Non}(W)$
 $\text{Every}(W) \text{Any}(W) \text{Some}(Y) \text{Non}(W)$
 $\text{Every}(_) \text{Any}(X) \text{Some}(Y) \text{Non}(Z)$
 $\text{Every}(_) \text{Any}(_) \text{Some}(_) \text{Non}(Z)$
 \dots
 $\text{Every}(_) \text{Any}(_) \text{Some}(_) \text{Non}(\dots)$

Express-ability

$(1) = (0) = (1+0)$

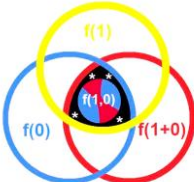

The Real Uni...Verse
Zim Mathematics

11

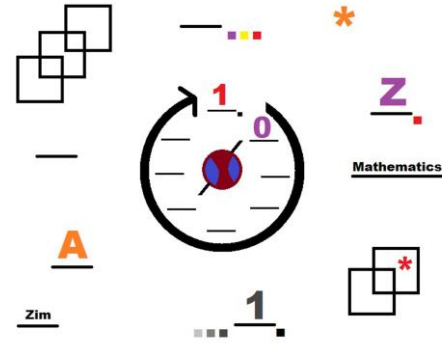

Mathematics

Zim

12

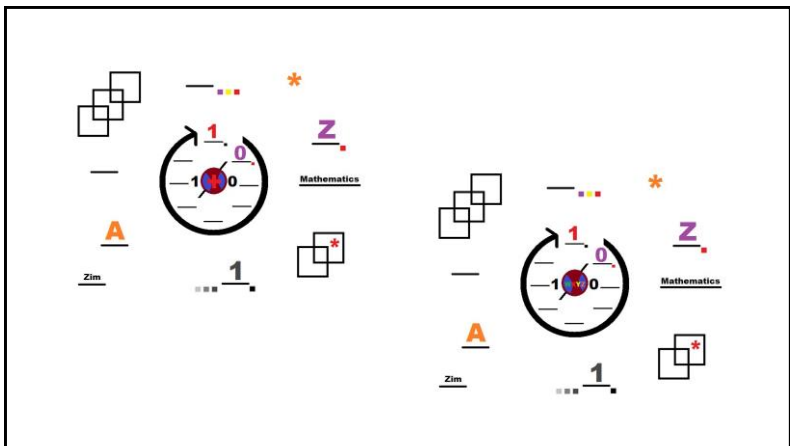

13

Principal / Pseudo Mathematics & Logic - In terms of Express-ability, Expression(s)/Non-Expression(s)

Principal/Pseudo Number Object(s)

—
 —, —
 —, —, —
 —, —, —, —
 —, —, —, — ... —

(1) = (0) = (1+0) as Principal Object(s)/Non-Principal Object(s)

14

Principal / Pseudo Mathematics & Logic - In terms of Express-ability, Expression(s)/Non-Expression(s)

Negative Number Object(s)

—
 —, —
 —, —, —
 —, —, —, —
 —, —, —, — ... —

As Partially Expressed

15

Principal / Pseudo Mathematics & Logic - In terms of Express-ability, Expression(s)/Non-Expression(s)

Math & Logic of Principal / Pseudo Number Object(s)

—
 —, —
 —, —, —
 —, —, —, —
 —, —, —, — ... —

As Completely/Partially Expressed

16

Principal / Pseudo Mathematics & Logic - In terms of Express-ability, Expression(s)/Non-Expression(s)

With Principal / Pseudo Express-abilities

Every(X)Any(X)Some(X)Non(X)
 Every(A)Any(B)Some(C)Non(D) ____.

Every(X)Any(X)Some(X)Non(X)
 Every(E)Any(F)Some(G)Non(H) __, __.

...

Every(X)Any(X)Some(X)Non(X)
 Every(W)Any(X)Some(Y)Non(Z) __, __, ... __.

Express-able Principal Object(s) within Open Domains

17

Principal / Pseudo Mathematics & Logic - In terms of Express-ability, Expression(s)/Non-Expression(s)

With Principal / Pseudo Express-abilities

Every(A)Any(A)Some(A)Non(A)
 Every(A)Any(B)Some(C)Non(D) ____.

Every(B)Any(B)Some(B)Non(B)
 Every(E)Any(F)Some(G)Non(H) __, __.

...

Every(Z)Any(Z)Some(Z)Non(Z)
 Every(W)Any(X)Some(Y)Non(Z) __, __, ... __.

Express-able Principal Object(s) within Open Domains

18

Principal / Pseudo Mathematics & Logic - In terms of Express-ability, Expression(s)/Non-Expression(s)

With Principal / Pseudo Express-abilities

Every(X)Any(X)Some(X)Non(X)
 Every(A)Any(B)Some(C)Non(D) ____.

Every(X)Any(X)Some(X)Non(X)
 Every(E)Any(F)Some(G)Non(H) ____.

...

Every(X)Any(X)Some(X)Non(X)
 Every(W)Any(X)Some(Y)Non(Z) ____.

Express-able Principal Object(s) within Open Domains

19

Principal / Pseudo Mathematics & Logic - In terms of Express-ability, Expression(s)/Non-Expression(s)

With Principal / Pseudo Express-abilities

Every(A)Any(A)Some(A)Non(A)
 Every(A)Any(B)Some(C)Non(D) ____.

Every(B)Any(B)Some(B)Non(B)
 Every(E)Any(F)Some(G)Non(H) ____.

...

Every(Z)Any(Z)Some(Z)Non(Z)
 Every(W)Any(X)Some(Y)Non(Z) ____.

Express-able Principal Object(s) within Open Domains

20

Open Domain Development with System(s) Expression

Every(X) Any(X) Some(X) Non(X) ___

Complete Expression of object(s) gives all available information for Principal Logic, Principal and/or Pseudo Logic, and Developable and/or Reducible Open Domains

Partial Expression(s) do not make available enough information and are only Reducible or Developable

21

Open Domain Development with System(s) Expression

Every() Any() Some() Non() ___

Or The "I am that I am"

**Every(_) Every(X) Any(X) Some(X) Non(X)
Any(_) Every(X) Any(X) Some(X) Non(X)
Some(_) Every(X) Any(X) Some(X) Non(X)
Non(_) Every(X) Any(X) Some(X) Non(X)**



22

Open Domains as System / Non-System Expressions of Principal and/or Incomplete Objects

With Object/Objects Expression Variations (NOT as a "Hierarchal" Construct)

<p><u>The Question</u></p> <p><u> 1, 0.</u></p> <p><u> , , . . .</u></p> <hr style="width: 50%; margin: auto;"/> <p>The Answer</p>	<p><u>The Question</u></p> <p><u> 1, 0.</u></p> <hr style="width: 50%; margin: auto;"/> <p>Question II</p>
---	--

23

OMS

1

 X,X,X,X,W,X,Y,Z

0

=

All Things Considered



24

OMS

$$\frac{1 \quad \text{---} \quad 0}{\text{---} \quad \text{---} \quad \dots \quad \text{---}}$$

W,X,Y,Z



=

$$\frac{\text{---} \quad \text{---}}{\text{---} \quad \text{---} \quad \dots \quad \text{---}}$$

1



25

Open Domains as System / Non-System Expressions
(Develop-able) or (Reducible) Source Outlines



→



=



$$\frac{1}{\text{---}}$$

→



=





26

Mathematical Open Domain Development
With "Known" Pseudo Systems & Their Expressions

(A-Z)	(=)	(+)	(1)
(1), (0)	(A), (B)	(1), (0)	(A), (B)
(1), (2) ... (N)	(1), (2) ... (N)	(1), (2) ... (N)	(1), (2) ... (N)
Or	Or	Or	Or
(A), (B) ... (Z)	(A), (B) ... (Z)	(A), (B) ... (Z)	(A), (B) ... (Z)



Expression itself is challenged here. Not surprisingly though.

=

27

Mathematical Open Domain Development
With "Known" Pseudo Systems & Their Expressions

(1)	(0)	(1+0)	(1,0)
(X), (Y)	(X), (Y)	(X), (Y)	(X), (Y)
(X), (Y) ... (Z)	(X), (Y) ... (Z)	(X), (Y) ... (Z)	(X), (Y) ... (Z)



=

28

Mathematical Open Domain Development

With "Known" Pseudo Systems & Their Expressions

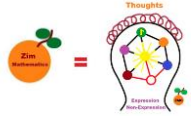
(1_x)	(0_x)	$(1+0)_x$	$(1,0)_x$
$(X), (Y)$	$(X), (Y)$	$(X), (Y)$	$(X), (Y)$
$(1), (2) \dots (N)$	$(1), (2) \dots (N)$	$(1), (2) \dots (N)$	$(1), (2) \dots (N)$
Or	Or	Or	Or
$(A), (B) \dots (Z)$	$(A), (B) \dots (Z)$	$(A), (B) \dots (Z)$	$(A), (B) \dots (Z)$



29

Image of . . . Nothing.

OMS

or Everything/Something,
Nothing/Everything,
Everything...

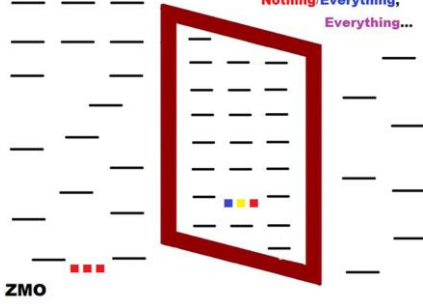

ZMO

30

Open Domains as Non-hierarchical System / Non-System Expressions

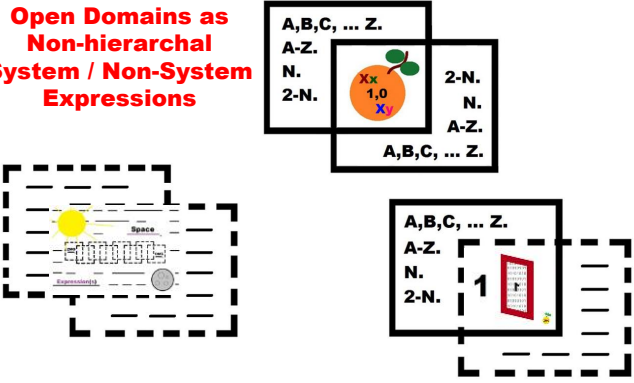

31

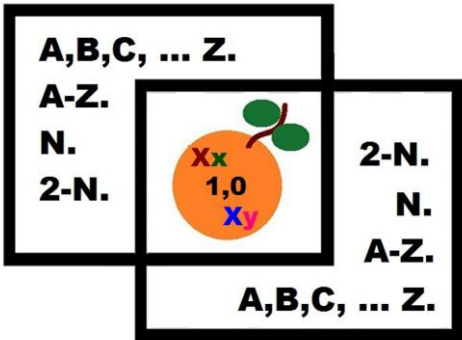

32

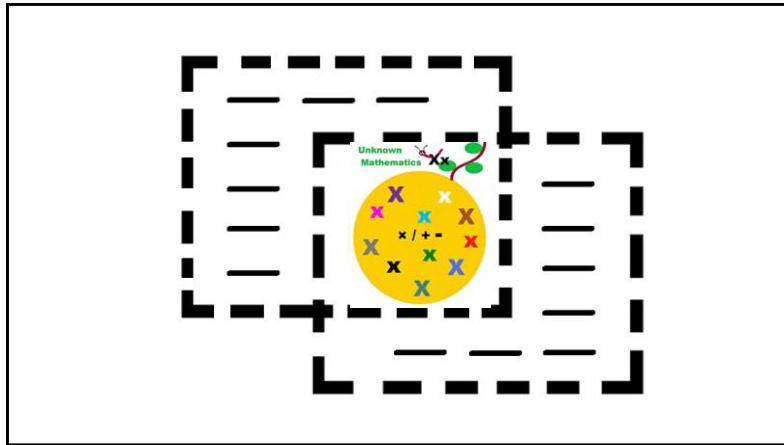

33

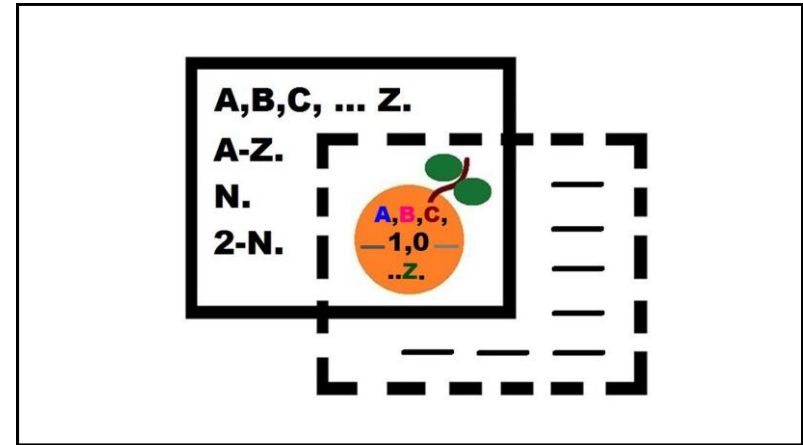

34

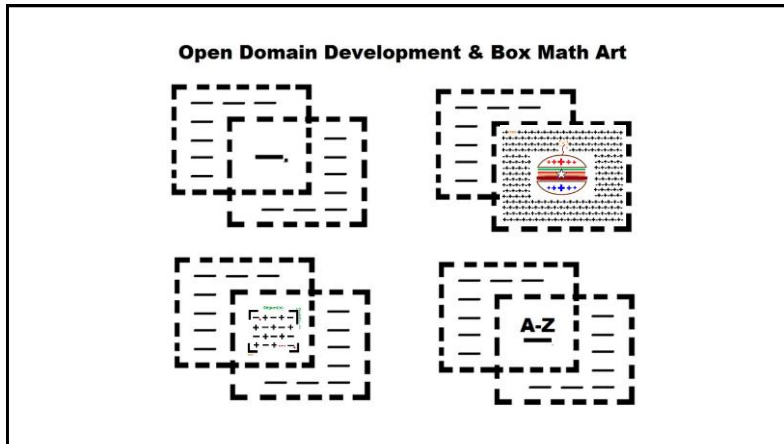

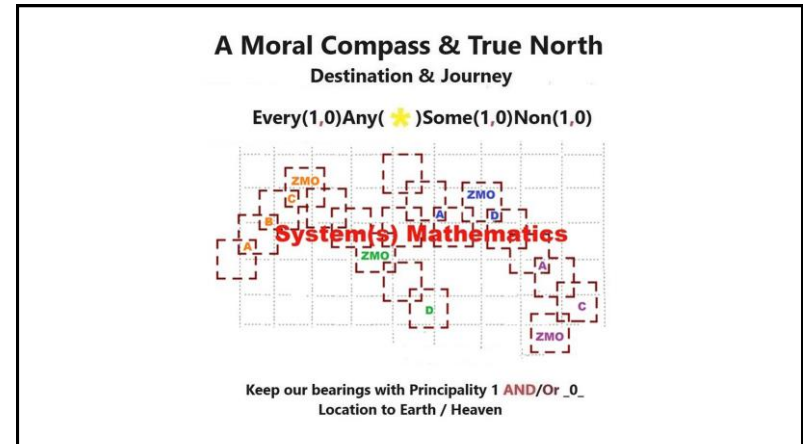

35



36

A Moral Compass & True North
Destination & Journey

Every(1,0)Any()Some(1,0)Non(1,0)



Systems Mathematics

Keep our bearings with Principality 1 AND/Or .0.
Location to Earth / Heaven

Metaphors as parametrizable – Systems AND/OR Sub Systems. Systems Math enables this: Locate Earthly Principal/Principle Object(s) and “location” in Heaven. The Promise and Jesus Principality serving here again as our analysis, rationale, AND Outcome (True North, Destination & Journey).

37

Biblical Creation as interpreted with Zim Mathematics

KJV. John 1:1 In the beginning was the Word, and the Word was with God, and the Word was God.

KJV Genesis 1 In the beginning God created the heaven and the earth. 2 And the earth was without form, and void; and darkness was upon the face of the deep. And the Spirit of God moved upon the face of the waters.

38

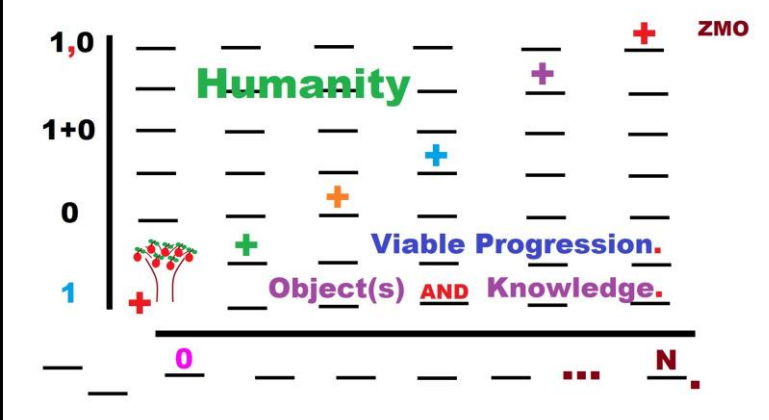

+ ZMO

Humanity

Viable Progression.

Object(s) AND Knowledge.

39

Zim Olson & Zim Mathematics
Math Foundations + Logic.
Creative Math & Art.
Systems Interpretations.

www.zimmathematics.com

**All content available for preview,
download, copying and sharing. Past,
Present, Future. Permissions Posted
Online.**

40

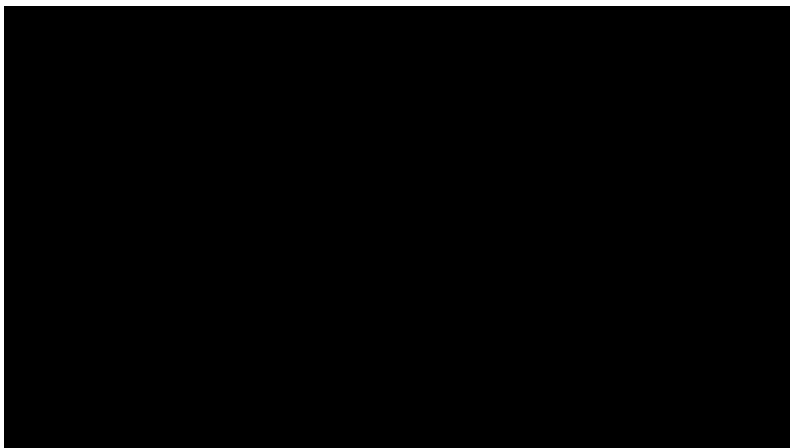

41